



OM SERIES MECHANICAL FLOWMETER

Volumetric flow measurement of clean liquids. Suitable for applications for safe area metering of fuel oils, lubricants, and other non-flammable viscous chemicals.

FEATURES / BENEFITS

- High accuracy oval gear technology with low pressure drop can be used in gravity-fed applications
- No requirement for flow conditioning or straight pipe runs makes them ideal for compact installations with limited space
- Robust aluminum mechanical registers
- Optional air eliminator/strainers

PRODUCT CONFIGURATION

PRODUCT IDENTIFIER **1**

OM = Oval Gear Meter

METER SIZE **2**

- 015** = 1/2" (15 mm), 0.26-10.6 GPM (1-40 L/min)
- 025** = 1" (25 mm), 2.6-40 GPM (10-150 L/min)
- 040** = 1 1/2" (40 mm), 4-66 GPM (15-250 L/min)
- 050** = 2" (50 mm), 8-130 GPM (30-500 L/min) (PPS rotors)
- 080** = 3" (80 mm), 10-200 GPM (35-750 L/min)
- 080E** = 3" Extended flow (80 mm), 13-260 GPM (50-1000 L/min)
- 100** = 4" (100 mm), 20-400 GPM (75-1550 L/min)
- 100E** = 4" Extended Flow (100 mm), 40-660 GPM (150-2500 L/min) (only available with Aluminum Rotors)

BODY MATERIAL **3**

- A** = Aluminum
- E** = Extended flow Aluminum (OM080E & OM100E)
- S** = 316L Stainless Steel (OM015 - OM080)

ROTOR MATERIAL / BEARING TYPE **4**

- 00** = PPS / No Bearing
- 10** = Keishi cut PPS / No Bearing
- 44** = Aluminum / hardened steel roller bearing (OM100E only)
- 51** = Stainless Steel / Carbon Ceramic (OM015-OM080)
- 71** = Keishi cut, Stainless Steel / Carbon Ceramic (OM015-OM080) (for high viscosity liquids)

O-RING MATERIAL **5**

- 1** = Viton™ 5°F min. (-15°C)
- 3** = Teflon encapsulated Viton™ (includes KALREZ shaft seals on 080 - 100E sizes) 5° F min. (-15° C)
- 4** = Buna-N (Nitrile), -40° F minimum (-40° C)

MAXIMUM TEMPERATURE LIMIT **6**

-8 = 176° F (80° C) max.

PROCESS CONNECTIONS **7**

- 00** = No fittings (025-100E)
- 10** = BSPP (G) female threaded (ISO 228)
- 20** = NPT female threaded
- 40** = ANSI-150 RF Flanged
- 50** = ANSI-300 RF Flanged (015-050)
- 60** = PN16 DIN Flanged

MECHANICAL REGISTERS **8**

- M3** = 4 digit mechanical totalizer - litre
Totalizer capacity
(OM015-OM040) 9999.9 litre
(OM050-OM100E) 99999 litre
- M4** = 4 digit mechanical totalizer - US gallons
Totalizer capacity
(OM015-OM040) 9999.9 gallon
(OM050-OM100E) 99999 gallon
- V1** = 5 digit mechanical reset register - litre
Total capacity
(OM50-OM100E) 999999 litre

1
2
3
4
5
6
7
8
 --->>>> **OM 100 A 51 1 -8 10 M3**

APPLICATIONS

- Automotive
- Aviation
- Mining
- Power
- Chemical
- Pharmaceutical
- Food
- Paint
- Petroleum Industries
- Environmental Applications

SPECIFICATIONS

	OM015	OM025	OM040	OM050	OM080	OM80E	OM100	OM100E
Nominal Size:	1/2" (15 mm)	1" (25 mm)	1-1/2" (40 mm)	2" (50 mm)	3" (80 mm)	3" (80 mm)	4" (100 mm)	4" (100 mm)
Nominal Flow Range* @ 3cP:	0.26-10.6 GPM (1 - 40 L/min)	2.6-40 GPM (10-150 L/min)	4-66 GPM (15-250 L/min)	8-118 GPM (30-450 L/min) (SS rotors)	10-200 GPM (35-750 L/min)	13-260 GPM (50-1000 L/min)	20-400 GPM (75-1500 L/min)	40-660 GPM (150-2500 L/min)
				8-130 GPM (30-500 L/min) (PPS rotors)				
Accuracy:	±1% of reading for M registers			±1% of reading for M registers (±0.5% for V registers)				
Repeatability:	Typically ± 0.03% of reading							
Ambient Temp. Range	5° F - 176° F (-15° C - 80° C)							
Max. Pressure (threaded)	580 psi (40 bar)	580 psi (40 bar)	435 psi (30 bar)	285 psi (20 bar)	175 psi (12 bar)	175 psi (12 bar)	145 psi (10 bar)	145 psi (10 bar)
M Register	4 digit resettable & NEMA 4 (IP65)							
V Register	n/a			5 digit resettable & NEMA 3S (IP54)				
Recommended Filtration:	100 mesh (150 µm)			40 mesh (350 µm)				
Face-to-Face Dimension A - Threaded	4.33" (110 mm)	5.39" (137 mm) AL	7.4" (188 mm)	8.35" (212 mm)	10.5" (266 mm)	11.6" (294 mm)	11.6" (294 mm)	12.6" (320 mm)
		6.93" (176 mm) SS						
Face-to-Face Dimension A - Flanged	7.44" (189 mm)	7.8" (198 mm) AL	9.92" (252 mm)	10.91" (277 mm)	13.93" (354 mm)	15.04" (382 mm)	15.28" (388 mm)	16.3" (414 mm)
		9.33" (237 mm) SS						
Meter Base-to-Register Top - Dimension B	7.01" (178 mm)	7.4" (188 mm) AL	8.94" (227 mm)	9.33" (237 mm)	10.63" (270 mm)	11.34" (288 mm)	13.11" (333 mm)	16.4" (416 mm)
		8.43" (214 mm) SS						
Meter Cap Width	4.33" (110 mm)	4.72" (120 mm)	6.23" (160 mm)	7.09" (180 mm)	9.53" (242 mm)	11.5" (292 mm)	11.5" (292 mm)	13.1" (332 mm)

*Maximum flow reduces as viscosity increases, see flow de-rating guide.
Max recommended Pressure drop is 14.5 psi (1 bar).

DIMENSIONS

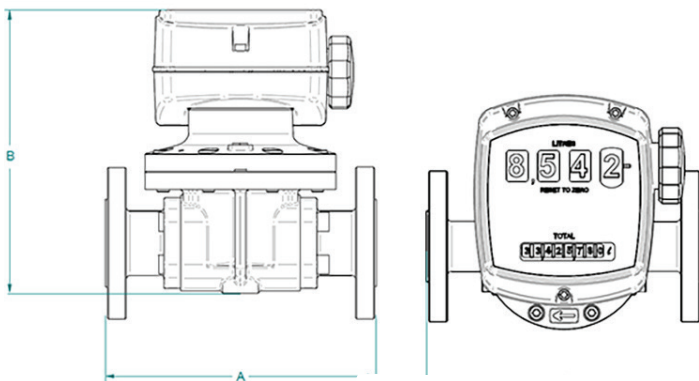



APPROVALS







NEMA
3S / 4

IP54/65

	3-A Sanitary Standards, Inc. is an independent, not-for-profit corporation dedicated to advancing hygienic equipment design for the food, beverage, and pharmaceutical industries.
ATEX	European directive describing the equipment allowed in an environment with an explosive atmosphere.
	European Explosive Atmosphere Symbol
	Conformity European. Product has been reviewed to one or more of 21 European directives
	Factory Mutual Approved to US Standards.
	Factory Mutual Approved to Canadian and US standards
	Factory Mutual Approved to Canadian standards
	Federal Communication Commission
	International Electrotechnical Committee logo; use of the logo by an organization only shows an association with the IECEx, it does not infer any compliance with standards.
IPxx	Ingress Protection Code
NEMA	National Electrical Manufacturers Association
	European Directive on Restriction of Hazardous Substances
	Canadian Standards Association
	Canadian Standards Association certified to Canadian and US standards
	Manufacturers, regulators and consumers look to NSF International for the development of public health standards and certification programs that help protect the world's food, water, consumer products and environment.

This guide is a generic explanation of the approval marks listed throughout the catalog. See individual product pages for what approvals apply to what products. Approvals vary by product line and may be dependent on meter application.

For additional approval details, please visit gpi.net/approvals.

	Underwriters Laboratories listed to US standards
	Underwriters Laboratories listed to Canadian and US standards
	Underwriters Laboratories listed to Canadian standards
	European directive on waste electrical and electronic equipment (WEEE)